



Cambridge IGCSE™

CANDIDATE
NAME

CENTRE
NUMBER

--	--	--	--	--

CANDIDATE
NUMBER

--	--	--	--



COMBINED SCIENCE

0653/31

Paper 3 Theory (Core)

May/June 2022

1 hour 15 minutes

You must answer on the question paper.

No additional materials are needed.

INSTRUCTIONS

- Answer **all** questions.
- Use a black or dark blue pen. You may use an HB pencil for any diagrams or graphs.
- Write your name, centre number and candidate number in the boxes at the top of the page.
- Write your answer to each question in the space provided.
- Do **not** use an erasable pen or correction fluid.
- Do **not** write on any bar codes.
- You may use a calculator.
- You should show all your working and use appropriate units.

INFORMATION

- The total mark for this paper is 80.
- The number of marks for each question or part question is shown in brackets [].
- The Periodic Table is printed in the question paper.

This document has **20** pages. Any blank pages are indicated.

1 Fig. 1.1 is a diagram of the female reproductive system in humans.

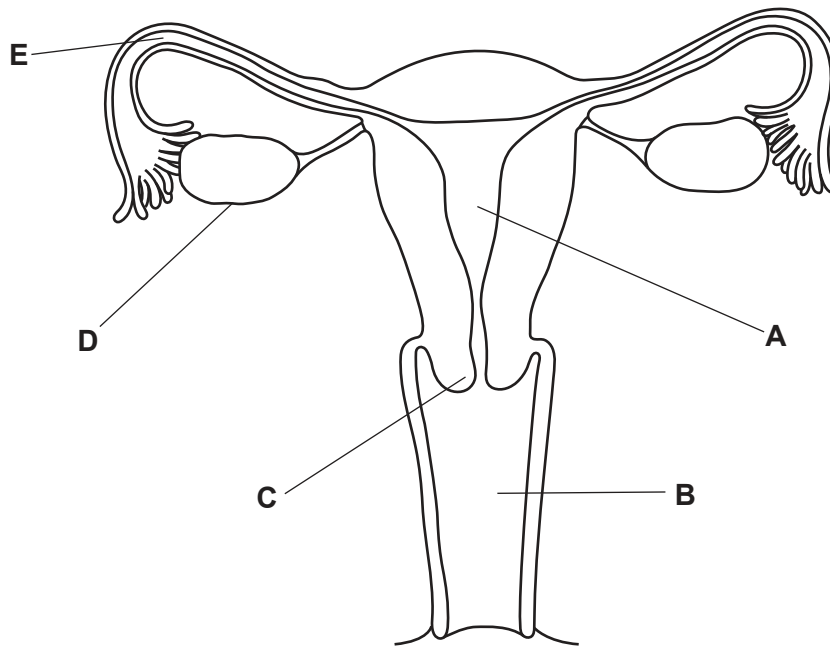

Fig. 1.1

(a) State the letter in Fig. 1.1 that shows:

the position of the cervix

where fertilisation takes place

where the fetus develops.

[3]

(b) Describe what happens to the lining of the uterus during the first few days of the menstrual cycle.

.....
 [1]

(c) Complete these sentences about fertilisation in humans.

The fusion of the nuclei of the egg and sperm produces a fertilised cell called a

.....

This cell divides to form a ball of cells called an

[2]

[Total: 6]

2 (a) An aqueous solution of salt **MX** is made by dissolving solid **MX** in water.

(i) Identify the solvent and the solute in aqueous **MX**.

solute

solvent

[2]

(ii) A student tests separate samples of aqueous **MX**.

The results are shown in Table 2.1.

Complete Table 2.1 by naming the ions that these tests show are in aqueous **MX**.

Table 2.1

test	result	name of ion
add aqueous sodium hydroxide	green precipitate, insoluble in excess	
add aqueous barium ions under acidic conditions	white precipitate	

[2]

(b) A student makes an aqueous solution of **MX** by reacting excess metal **M** with dilute acid **HX**.

The student then separates the excess, unreacted solid metal **M** from the reaction mixture.

(i) Suggest how the student separates solid metal **M** from the reaction mixture.

..... [1]

(ii) State whether this separation process is a chemical change or a physical change.

Explain your answer.

change

explanation

..... [1]

(iii) State the effect of increasing the temperature on the rate of this reaction.

.....
..... [1]

(iv) During the reaction between metal **M** and dilute acid **HX**, atoms of **M** become cations.

Explain how atoms become cations.

.....
..... [1]

(v) Suggest what happens to the value of the pH of the reaction mixture during the reaction between excess metal **M** and dilute acid **HX**.

.....
..... [1]

[Total: 9]

- 3 Fig. 3.1 shows a man pushing a shopping trolley forwards.



Fig. 3.1

- (a) Fig. 3.2 shows four forces, **P**, **Q**, **R** and **S**, acting on the shopping trolley as the man pushes it.

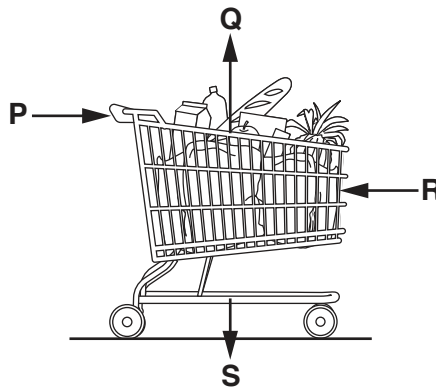

Fig. 3.2

State the name of force **S**.

.....

[1]

- (b) The man pushes the trolley with force **P** = 15 N. The trolley moves at a constant speed.

- (i) State the magnitude of force **R**.

force **R** = N [1]

- (ii) The man increases force **P** to 20 N.

Forces **Q**, **R** and **S** do not change.

Calculate the resultant force on the trolley.

resultant force = N [1]

(iii) Describe how the change in force **P** affects the motion of the trolley.

.....
..... [1]

(c) As the man pushes the trolley, he transfers 150 J of energy to the trolley.

(i) State the work done on the trolley by the man. Give the unit of your answer.

work done = unit [1]

(ii) Complete the boxes to show the useful energy transfer as the man pushes the trolley.

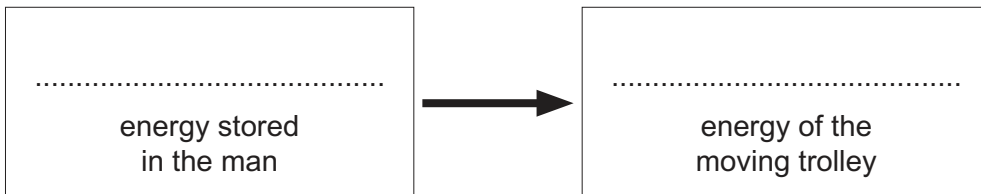

[2]

(iii) The man lets go of the moving trolley. The trolley slows down and stops.

Explain why the trolley slows down.

.....
.....
..... [2]

[Total: 9]

- 4 (a) Fig. 4.1 is an image of a white blood cell.

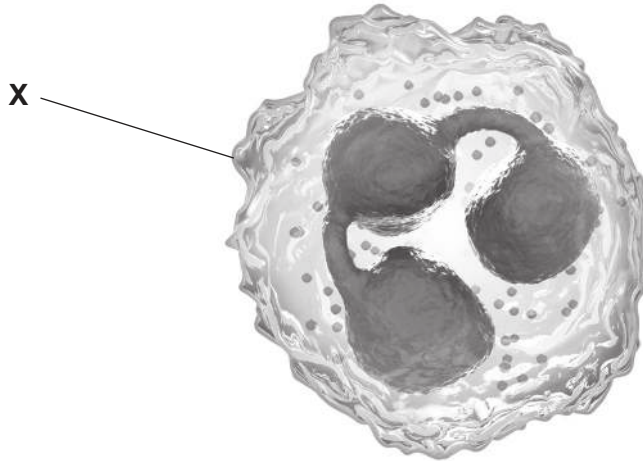

Fig. 4.1

- (i) Identify the part labelled **X** in Fig. 4.1.

..... [1]

- (ii) Use Fig. 4.1 to state **two** reasons why this cell is **not** identified as a plant cell.

1

2 [2]

- (iii) State **one** function of white blood cells.

..... [1]

- (b) A blood sample can be separated into its main components.

Fig. 4.2 is a diagram showing a separated blood sample.

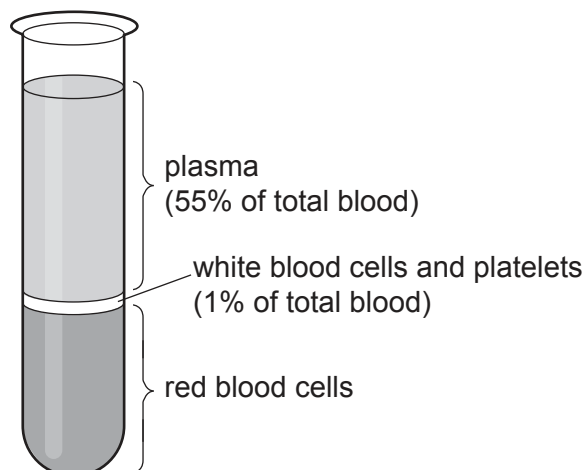

Fig. 4.2

(i) Calculate the percentage of blood that is red blood cells in Fig. 4.2.

..... % [1]

(ii) Red blood cells transport oxygen.

Explain why oxygen moves from the lungs into red blood cells.

Use ideas about diffusion in your answer.

.....
.....
..... [2]

(c) Blood plasma transports soluble molecules.

Large insoluble food molecules in our diet are digested into small soluble molecules.

(i) Circle the name of the soluble molecules proteins are made from.

amino acids fatty acids glycerol glucose starch

[1]

(ii) Complete these sentences about digestion.

Choose words from the list.

Each word may be used once, more than once or not at all.

active absorption anus egestion excretion
ingestion pancreas oesophagus mechanical

Food is taken into the mouth by the process of

The food then passes down the to the stomach.

In the stomach there are two types of digestion, chemical and

.....

Food that has been digested passes into the blood by the process of

.....

[4]

[Total: 12]

5 (a) Fossil fuels release heat energy during combustion.

(i) State the name given to any chemical reaction that releases heat energy.

..... [1]

(ii) State the name of the fossil fuel in which methane is the main constituent.

..... [1]

(iii) Complete the dot-and-cross diagram in Fig. 5.1 to show all the outer shell electrons in a molecule of methane.

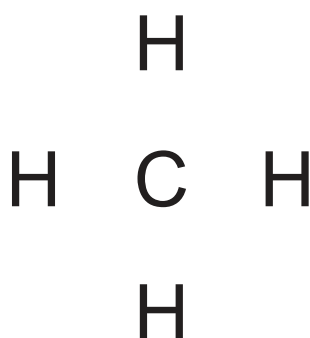

Fig. 5.1

[2]

(b) Magnesium burns in pure oxygen to form compound **Y** only.

Compound **Y** is a white solid base that reacts with dilute sulfuric acid to form compound **Z** and water only.

(i) State whether magnesium is oxidised or reduced when it burns.

Explain your answer.

.....

..... [1]

(ii) Identify compound **Y** and compound **Z**.

compound **Y**

compound **Z**

[2]

(iii) Describe **two** physical properties of magnesium.

1

2

[2]

[Total: 9]

6 (a) Electromagnetic waves transfer energy through space from the Sun to the Earth.

(i) State whether this transfer of energy through space is by conduction, convection or radiation.

Explain your answer.

.....

.....

..... [2]

(ii) Fig. 6.1 shows an incomplete electromagnetic spectrum.

The Sun emits waves in all parts of the electromagnetic spectrum.

Complete Fig. 6.1 to show all parts of the electromagnetic spectrum.

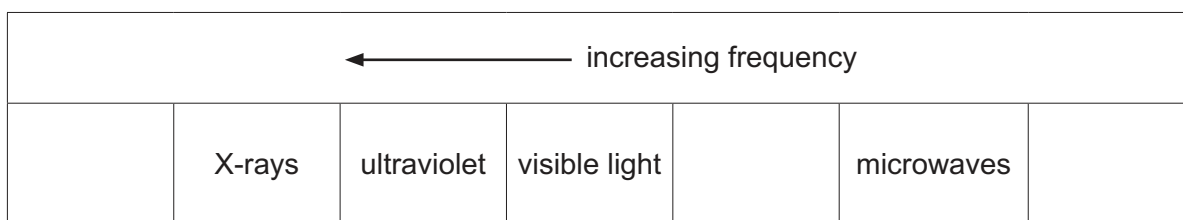

Fig. 6.1

[2]

(iii) Visible light waves take 8 minutes to travel from the Sun to the Earth.

Suggest how long it takes for ultraviolet waves to travel from the Sun to the Earth.

Give a reason for your answer.

time taken

reason

[1]

(b) Fig. 6.2 shows the Sun shining on a puddle of water. A student sees an image of the Sun in the puddle of water.

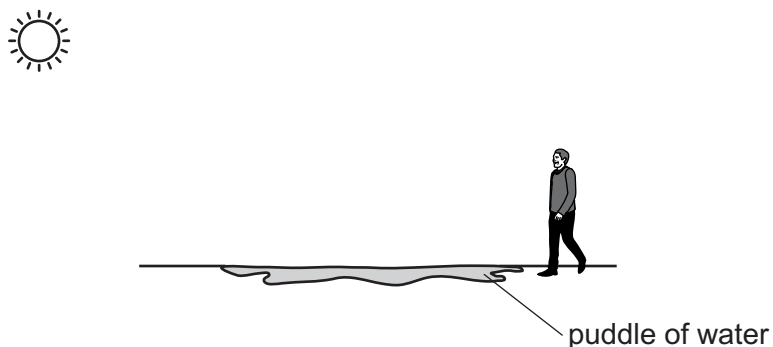

Fig. 6.2

(i) The puddle acts as a plane mirror.

On Fig. 6.2, draw a ray diagram to show how the student can see an image of the Sun in the puddle.

Your diagram should include the position of the image of the Sun. [3]

(ii) Explain, in terms of water molecules, what happens as the Sun transfers energy to the puddle and the water in the puddle dries up.

.....
.....
..... [2]

[Total: 10]

7 (a) Fig. 7.1 shows part of a food web from the ocean.

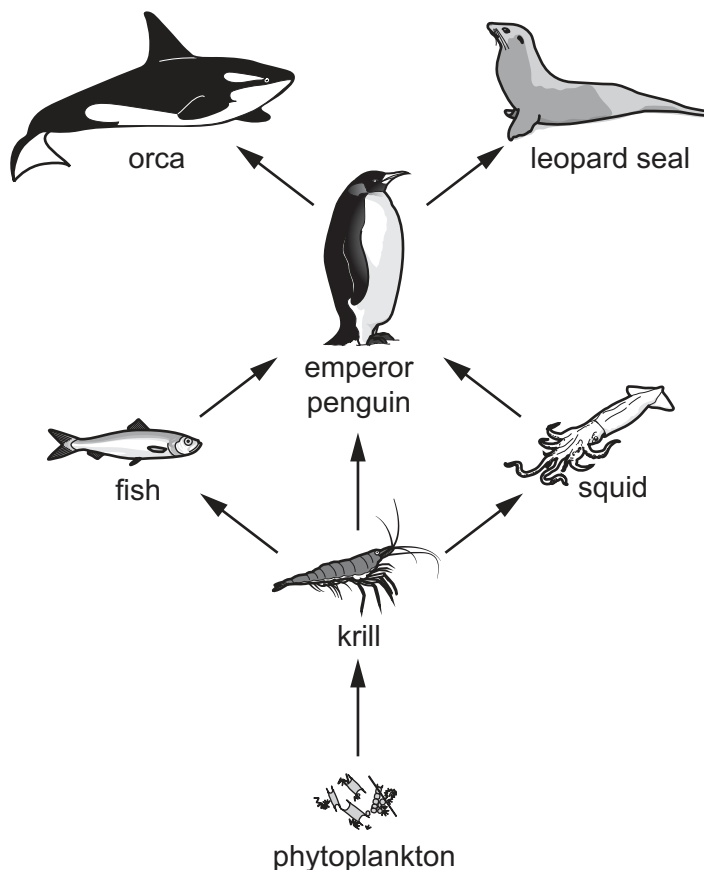

Fig. 7.1

(i) Phytoplankton are producers.
Define the term producer.

.....
 [2]

(ii) Identify a primary consumer in Fig. 7.1.

..... [1]

(iii) Identify **two** organisms eaten by emperor penguins in Fig. 7.1.

1

2

[1]

(iv) Orcas also eat fish.

Draw **one** arrow on Fig. 7.1 to show this feeding relationship.

[1]

(b) Fig. 7.2 shows part of the carbon cycle.

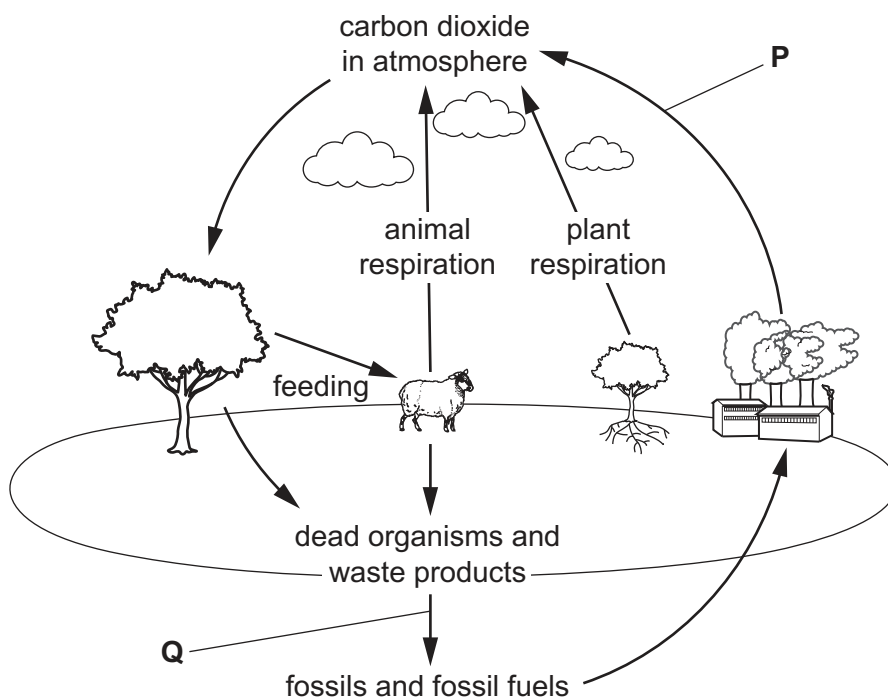

Fig. 7.2

(i) Identify processes **P** and **Q** in Fig. 7.2.

P

Q

[2]

(ii) Deforestation increases the concentration of carbon dioxide in the atmosphere.

List **two other** undesirable effects of deforestation.

1

2

[2]

[Total: 9]

8 (a) Lithium, sodium and potassium are metals in Group I of the Periodic Table.

Chlorine, bromine and iodine are halogens in Group VII of the Periodic Table.

Helium, neon and argon are elements in Group VIII of the Periodic Table.

(i) State the trend in the density of the elements going down Group I.

..... [1]

(ii) State the trend in the colour of the elements going down Group VII.

..... [1]

(iii) Identify **one** similarity between the elements in Group VIII.

..... [1]

(b) Aluminium, calcium, iron and sodium are in different groups of the Periodic Table.

Place these metals in order of reactivity, from most to least reactive.

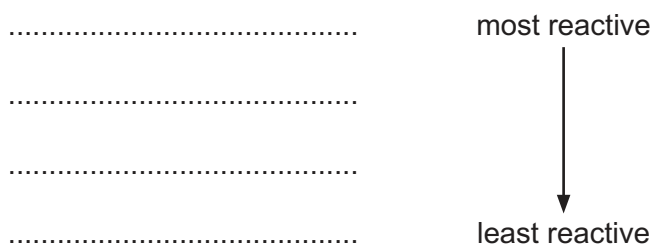

[2]

(c) An atom of sodium is represented as shown.



Deduce the number of protons and the number of neutrons in this atom.

protons

neutrons

[2]

(d) State **one** use of helium.

..... [1]

[Total: 8]

- 9 (a) Complete the following sentences using the terms shown.

Each term may be used once, more than once or not at all.

current

positive charge

ohms

resistance

series

volts

A flow of electric charge is called a

An ammeter is used to measure

A potential difference is measured in

[3]

- (b) Fig. 9.1 shows an electric circuit.

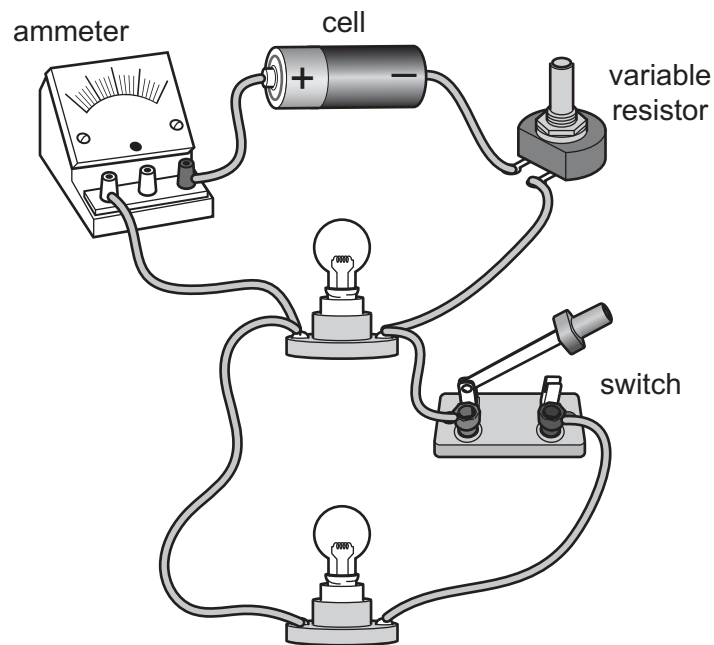

Fig. 9.1

- (i) Fig. 9.2 shows an incomplete circuit diagram for the circuit in Fig. 9.1.
On Fig. 9.2, complete the circuit diagram.

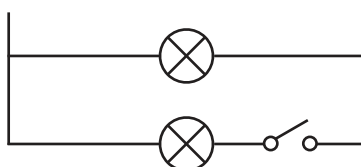

Fig. 9.2

[3]

- (ii) When the switch is off, the reading on the ammeter is 0.5A.
When the switch is on, the reading on the ammeter increases.
Explain why the reading on the ammeter increases.

.....

[2]

[Total: 8]

Permission to reproduce items where third-party owned material protected by copyright is included has been sought and cleared where possible. Every reasonable effort has been made by the publisher (UCLES) to trace copyright holders, but if any items requiring clearance have unwittingly been included, the publisher will be pleased to make amends at the earliest possible opportunity.

To avoid the issue of disclosure of answer-related information to candidates, all copyright acknowledgements are reproduced online in the Cambridge Assessment International Education Copyright Acknowledgements Booklet. This is produced for each series of examinations and is freely available to download at www.cambridgeinternational.org after the live examination series.

Cambridge Assessment International Education is part of Cambridge Assessment. Cambridge Assessment is the brand name of the University of Cambridge Local Examinations Syndicate (UCLES), which is a department of the University of Cambridge.

The Periodic Table of Elements

Group									
I	II	III	IV	V	VI	VII	VIII		
3 Li lithium 7	4 Be beryllium 9	5 B boron 11	6 C carbon 12	7 N nitrogen 14	8 O oxygen 16	9 F fluorine 19	10 Ne neon 20		
11 Na sodium 23	12 Mg magnesium 24	13 Al aluminium 27	14 Si silicon 28	15 P phosphorus 31	16 S sulfur 32	17 Cl chlorine 35.5	18 Ar argon 40		
19 K potassium 39	20 Ca calcium 40	21 Sc scandium 45	22 Ti titanium 48	23 V vanadium 51	24 Cr chromium 52	25 Mn manganese 55	26 Fe iron 56	27 Co cobalt 59	28 Ni nickel 59
37 Rb rubidium 85	38 Sr strontium 88	39 Y yttrium 89	40 Zr zirconium 91	41 Nb niobium 93	42 Mo molybdenum 96	43 Tc technetium —	44 Ru ruthenium 101	45 Rh rhodium 103	46 Pd palladium 106
55 Cs caesium 133	56 Ba barium 137	57–71 lanthanoids	72 Hf hafnium 178	73 Ta tantalum 181	74 W tungsten 184	75 Re rhenium 186	76 Os osmium 190	77 Ir iridium 192	78 Pt platinum 195
87 Fr francium —	88 Ra radium —	89–103 actinoids	104 Rf rutherfordium —	105 Db dubnium —	106 Sg seaborgium —	107 Bh bohrium —	108 Hs hassium —	109 Mt meitnerium —	110 Ds darmstadtium —
							80 Hg mercury 201	81 Tl thallium 204	82 Pb lead 207
							48 Cd cadmium 112	49 In indium 115	50 Sn tin 119
							29 Cu copper 64	30 Zn zinc 65	31 Ga gallium 70
							33 As arsenic 75	34 Se selenium 79	35 Br bromine 80
							51 Sb antimony 122	52 Te tellurium 128	53 I iodine 127
							83 Bi bismuth 209	84 Po polonium —	85 At astatine —
							112 Cn copernicium —	113 Nh nihonium —	114 Fl flerovium —
							111 Rg roentgenium —	116 Lv livermorium —	

1
H
hydrogen
1

Key

atomic number
atomic symbol
name
relative atomic mass

lanthanoids	57 La lanthanum 139	58 Ce cerium 140	59 Pr praseodymium 141	60 Nd neodymium 144	61 Pm promethium —	62 Sm samarium 150	63 Eu europium 152	64 Gd gadolinium 157	65 Tb terbium 159	66 Dy dysprosium 163	67 Ho holmium 165	68 Er erbium 167	69 Tm thulium 169	70 Yb ytterbium 173	71 Lu lutetium 175
actinoids	89 Ac actinium —	90 Th thorium 232	91 Pa protactinium 231	92 U uranium 238	93 Np neptunium —	94 Pu plutonium —	95 Am americium —	96 Cm curium —	97 Bk berkelium —	98 Cf californium —	99 Es einsteinium —	100 Fm fermium —	101 Md mendelevium —	102 No nobelium —	103 Lr lawrencium —

The volume of one mole of any gas is 24 dm³ at room temperature and pressure (r.t.p.).